



**Assembly Instructions**  
**Model: NS48**  
*-Chain not included-*

**Step 1 (FIG. 1)**

Lay back assembly on the floor  
 Attach the side frames using (2) 2¼" bolts  
 and (2) 4¼" eyebolts with nuts and washers  
 Insert pins into back assembly

**Step 2 (FIG. 2)**

Set swing upright and attach the seat  
 using (2) 5" eyebolts with nuts and washers  
 Then, push seat into pins and attach using  
 (2) 2¼" bolts







Hanging note: recommended distance  
 apart is 55" at 60" from the ground.

- (1) Seat
- (1) Back
- (2) Sideframe
- (1) Hardware pack

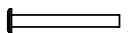
**TOOLS NEEDED**

**5/32" HEX KEY: INCLUDED**



Qty.	Description
4	 A - 2¼" bolt (1/4)
2	 B - 4¼" Eyebolt (5/16)
2	 C - 5" Eyebolt (5/16)
4	 5/16 Washer
4	 5/16 Nut
2	 5/16 Pin

\*Note: Prep eyebolt with nut and washer  
 Take nut to end of thread.

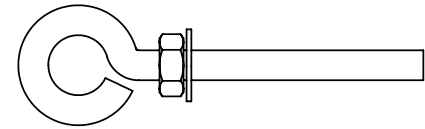

FIG. 1

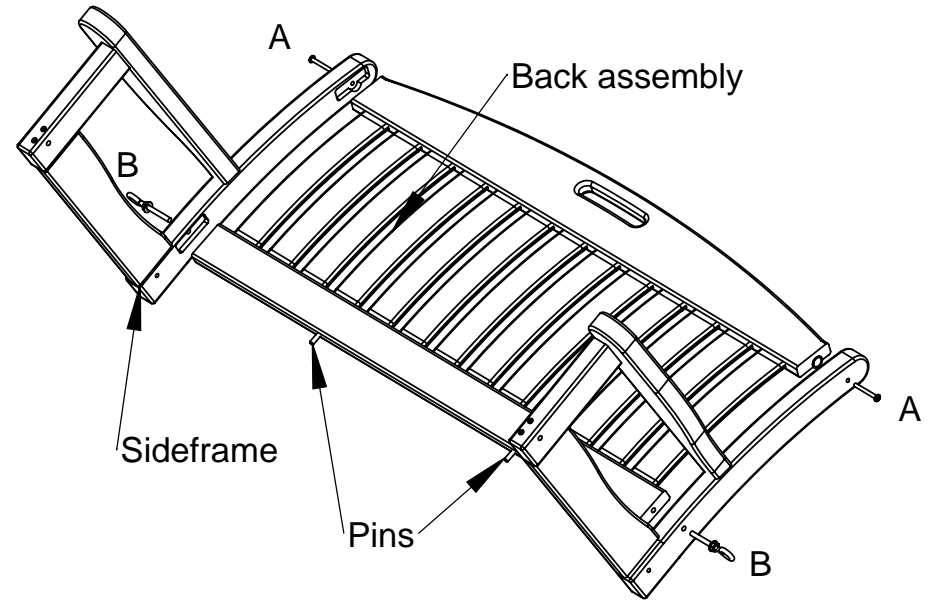

FIG. 2

